

**GEM<sup>®</sup>**



# 2016 ACCESSORY CATALOG





# GEM® PASSENGER VEHICLES

Transport people around campuses, facilities or neighborhoods in distinctive comfort. The GEM's spacious interior, intuitive ergonomics and open-air design make getting in and out easy. All forward-facing seats and quiet operation increase safety and promote connectivity and conversation among passengers.



Aluminum Wheels - Page 16



S-Box - Page 26

## THE PERFECT VEHICLE FOR:

- Student and Guest Transportation
- Valet and Customer Service
- Neighborhoods
- Police and Security Control
- Site and Campus Tours
- Families



Doors - Pages 17-19





# GEM® UTILITY VEHICLES

With 1,400 lbs. of payload, count on GEM® to get the job done efficiently, economically and sustainably—with zero emissions and lower operating costs than a gas-powered van or truck. Choose from hundreds of options and accessories to create the customized vehicle you need to maximize productivity, indoors or out.



60 Gallon Boomless Utility Sprayer - Page 31



Front & Side Tool Chests - Page 28

**THE PERFECT VEHICLE FOR:**

- Groundskeeping
- Facility Management
- Indoor Warehouse
- Housekeeping
- Hospitality
- Emergency Service



Boxside - Page 28





# THE RIGHT SOLUTION

When it comes to moving people and cargo with ease and efficiency, the vehicle you choose matters. Make the smart choice with the all-new electric GEM®. Polaris® engineered for a premium ride and long-lasting durability, the new GEM® has more built-in comfort and street-legal safety features than a golf cart, and it's more maneuverable, cost-efficient and sustainable than a van or truck. It offers a more spacious interior with the same compact footprint and quiet, electric power for low-cost, low-maintenance operation.

Now with more versatile options, GEM® can be customized to your needs—so you can drive, shuttle, haul and work with confidence that you've chosen a vehicle built for what you do. Drive one today and discover why GEM® is **the smarter way to move.™**



# GENUINE ENGINEERED ACCESSORIES



## TABLE OF CONTENTS

- POWER & CHARGING 8-10
- GARAGE 11
- CAB ACCESSORIES 12-15
- WHEELS 16
- ROOFS & DOORS 17-19
- WINDSHIELDS & WINDOWS 20-21
- BUMPERS & WINCHES 22-23
- LIGHTS 24-25
- PASSENGER CARRIERS 26-27
- UTILITY CARRIERS 28-31



## SOLAR

**PART #:** 2881506  
**FITMENT:** e4

**PART #:** 2881507  
**FITMENT:** e6, eL XD (with 2881663)

Extend your time between charges and battery life with a renewable source of energy - the sun!

The solar panel is lightweight, non-glass high efficiency Mono Crystalline Solar which is hail and impact resistant

Specifically designed and programmed to work with and match the Polaris® 48V battery set systems

Does not work with: Lithium Ion

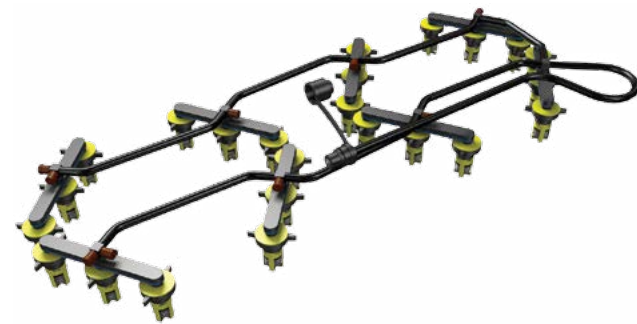

## BATTERY WATERING KITS

**PART #:** 2881635 - 12V  
**FITMENT:** e2, e4

**PART #:** 2881636 - 6V  
**FITMENT:** e6, eL XD

Filler works by replacing the battery's existing vent caps with valves that are interconnected with tubing, allowing the user to fill all cells of the battery from a single remote location

Each valve independently shuts off water flow to the cell when the proper electrolyte level is reached, allowing the batteries to be filled perfectly each time



## BATTERY FILLER SYSTEM FOR GEM® eM™1400

**PART #:** 2880201  
**FITMENT:** eM™1400, eM™1400 LSV

Filler works by replacing the battery's existing vent caps with valves that are interconnected with tubing, allowing the user to fill all cells of the battery from a single remote location

Each valve independently shuts off water flow to the cell when the proper electrolyte level is reached, allowing the batteries to be filled perfectly every time



## FAST CHARGER

**PART #:** 4015434 - 3kW  
**FITMENT:** e2, e4, e6, eL XD

Charge your GEM® up to 6X faster than the standard 120 volt on-board charger. Order quantity of 1 for up to 3X faster charge, and order quantity of 2 for up to 6X faster charge

Required, sold separately: Charger Mounting Kit (PN 2881853)

## J1772 3kW/6kW CHARGER MOUNTING KIT

**PART #:** 2881853  
**FITMENT:** e2, e4, e6, eL XD

This kit is required to install the fast charger options onto the vehicle

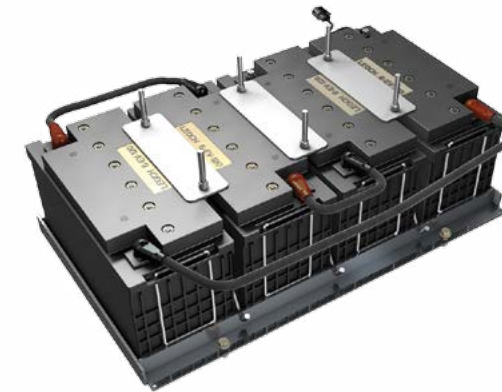

## BATTERIES

MAKE	PART #	FITMENT	DESCRIPTION
12V AGM Battery	4015462	e2, e4, e6, eL XD	Maintenance free battery that never needs filling (leak-free, spill-proof)
6V AGM Battery	4015463	e2, e4, e6, eL XD	Extended range maintenance free battery that never needs filling (leak-free, spill-proof)
12V Battery for use with Li-Ion options	4014770	e2, e4, e6, eL XD	12V battery for use with Li-Ion battery system to drive BMC
8.9 kW Li-Ion Battery Pack - 44V	4015495	e2, e4, e6, eL XD	44V Li-Ion battery pack - part of 8.9 kW system providing extended range and longer life
12.4 kW Li-Ion Battery Pack - 30V	4015532	e2, e4, e6, eL XD	30V Li-Ion battery pack - part of 12.4 kW system providing extended range and longer life
12.4 kW Li-Ion Battery Pack - 15V	4015533	e2, e4, e6, eL XD	15V Li-Ion battery pack - part of 12.4 kW system providing extended range and longer life
Li-Ion Battery Upfit Kit	2881852	e2, e4, e6, eL XD	Kit to upfit GEM® battery system to Li-Ion package (same kit for upfit to 8.9 or 12.4 system)



## RIDERX® DONGLE

**PART #:** 2879855  
**FITMENT:** e2, e4, e6, eL XD

Gain insight into your vehicle's range performance and track maintenance

## STATION CHARGERS

**PART #:** 2413421 - LCS-25P, 4.8 kW  
**FITMENT:** e2, e4, e6, eL XD

**PART #:** 2413422 - HCS-40P, 7.7 kW  
**FITMENT:** e2, e4, e6, eL XD

Hard wire a city infrastructure style charger at home or office





## SMART POWER TO MOVE YOU

Whether you travel just a few miles or drive all day, Polaris® GEM® offers versatile battery and charging options to fit your range requirements and ensure your GEM® will always be ready to move when you need it.

### CHOOSE THE BATTERY RIGHT FOR YOU

FLOODED ELECTROLYTE	STANDARD MAINTENANCE FREE	DISTANCE MAINTENANCE FREE	LITHIUM-ION 8.9 kWh	LITHIUM-ION 12.4 kWh
Value battery requires regular maintenance	Leak-free, spill-proof design never needs refilling	For increased distance, especially in hilly terrain	Lightweight and hard-working for maximum range and 2-3X more battery life	Maximum range for shuttle and other high-demand applications

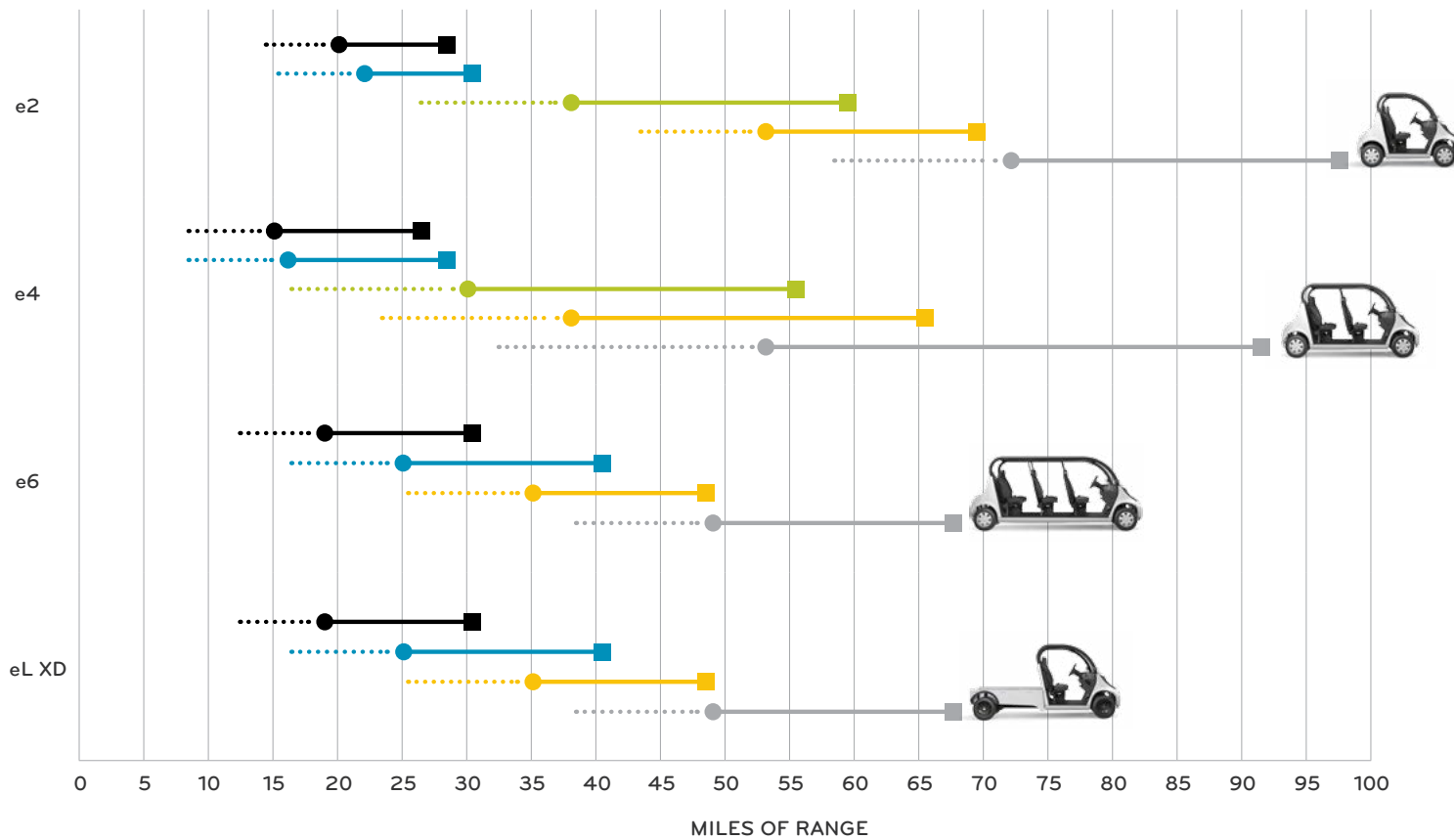

● Range on all Polaris® electric vehicles will vary depending on temperature, grade, payload and driving style. Average range value includes testing at 25 mph with 332 lbs. of cargo and a stop/start every 1,000 feet on a flat grade.  
■ NEV values attained via testing in accordance with NEV America requirements with continuous use on a horizontal grade.



### COVERS

PART #: 2687218  
FITMENT: e2

PART #: 2687219  
FITMENT: e4

PART #: 2687220  
FITMENT: e6

PART #: 2687221  
FITMENT: eL XD

Protects your vehicle in short or long term storage  
Water-resistant, washable, and designed not to scratch the finish of your vehicle  
Features a cinch strap to ensure a tight fit

## POLARIS POWER® PORTABLE GENERATORS



Polaris POWER® portable digital inverter generators are built for your outdoor needs and are tested to the same rigorous standards as every Polaris® product.



PARALLEL KIT - CETL APPROVED  
Part # 3410281



1000 WATT INVERTER GENERATOR  
Part # P13GDGANA

2000 WATT INVERTER GENERATOR  
Part # P13GDGBNA

3000 WATT INVERTER GENERATOR  
Part # P13GDGCNA



COVER - P1000  
Part # 2686441

COVER - P2000  
Part # 2686442

COVER - P3000  
Part # 2686443



GENERATOR OIL - quart  
Part # 2879383

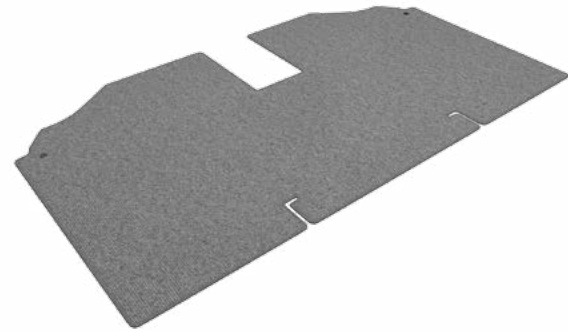

### CARPET FLOOR MATS

**PART #:** 2881866  
**FITMENT:** e2, eL XD

**PART #:** 2881867  
**FITMENT:** e4

**PART #:** 2881868  
**FITMENT:** e6

Plush carpeting features GEM® logo  
Protects your floor  
Includes mounting hardware

### GRAY TWO TONE SEATS

**PART #:** 2686216-317  
**FITMENT:** e2, e4, e6, eL XD

Enhance your GEM's style with two-toned seats

### LH ELECTRONIC POWER STEERING - EPS

**PART #:** 2881862  
**FITMENT:** e2, e4, e6, eL XD

Steer with less effort  
Electronic

### WINDSHIELD WASHER

**PART #:** 2881863  
**FITMENT:** e2, e4, e6, eL XD

Keep your windshield free from obstruction



### RUBBER FLOOR MATS

**PART #:** 5415568 - Front  
**FITMENT:** e2, e4, e6, eL XD

**PART #:** 5415569 - Rear  
**FITMENT:** e4, e6

Protects your floors from scuff marks,  
and provides added traction



### STEREO

**PART #:** 2881864  
**FITMENT:** e2, e4, e6, eL XD

Features large 6 inch speakers, AM/FM radio, CD player and CD, CD-R, CD-RW capabilities and 3.55mm Front Panel Auxiliary Input  
Face plate is detachable for added security



### HEATER

**PART #:** 2881865  
**FITMENT:** e2, e4, e6, eL XD

Provides fan and heat source to raise cab temperatures in electric vehicles  
Easy installation, includes heater, fan, mounting hardware, blower ducts and wiring







### CAB FRAME

**PART #:** 2880203  
**FITMENT:** eM1400

Heavy duty steel cab frame allows you to add many cab components, like a roof, doors or windshield to your vehicle



### WIPER KIT

**PART #:** 2880884  
**FITMENT:** eM1400, eM1400 LSV, M1400™

Clear rain and debris from your windshield with the flick of a switch.

Easy installation, includes all hardware, wiring and switches

Required, sold separately: Windshield Kit (PN 2880885) when used on GEM® eM™1400 LSV or eM™1400, Windshield Kit (PN 2879958) when used on Polaris® M1400™



### REVERSE WARNING KIT

**PART #:** 2876228  
**FITMENT:** eM1400, eM1400 LSV, M1400™

While in reverse, a beep will sound alerting those around you that you are backing up



### DIFFERENTIAL LOCK

**PART #:** 2880914  
**FITMENT:** M1400™

Easy to install, allows locking of rear differential for increased traction on slippery surfaces

Kit includes wiring and dash mounted selector switch



### SPEED KEY KIT

**PART #:** 2881000  
**FITMENT:** M1400™

Yellow Speed Key governs vehicle speed to 10 or 15 mph maximum

Owner can control the top speed available to individual operators

Requires controller programming, available from any GEM® Dealer



### SIDE MIRROR KIT

**PART #:** 2881001 - Driver  
**FITMENT:** eM1400, eM1400 LSV, M1400™

**PART #:** 2881002 - Passenger  
**FITMENT:** eM1400, eM1400 LSV, M1400™

Large mirror provides good visibility to the sides and rear of the vehicle

Easy installation

Required, sold separately: Cab Frame (PN 2880203) when used on GEM® eM™1400, Mounting Kit (PN 2879111) when used on any vehicle with Poly Doors



### TURN SIGNAL KIT

**PART #:** 2880882  
**FITMENT:** eM1400, M1400™

Includes front and rear turn signal lights, wiring and column mounted switch for operation



### HORN KIT

**PART #:** 2875048  
**FITMENT:** eM1400, eM1400 LSV, M1400™

Installs in the console area

Connects to the vehicle's battery power supply



### HEATER

**PART #:** 2880880  
**FITMENT:** eM1400, eM1400 LSV

Provides fan and heat source to raise cab temperatures in electric vehicles

Easy installation, includes heater, fan, mounting hardware, blower ducts and wiring



### UNDER SEAT STORAGE TUB

**PART #:** 2880202  
**FITMENT:** eM1400, eM1400 LSV

Gain extra storage with this storage tub

Fits underneath the seat





### ALUMINUM WHEELS - 14X165

**PART #:** 1522553  
**FITMENT:** e2, e4, e6, eL XD

Add styling to your GEM® with an aluminum rim  
Tires offer a smooth ride  
Rated for on-road driving  
Sold individually: order quantity of 4 for complete set



### FENDER FLARES - eL XD

**PART #:** 2881673  
**FITMENT:** eL XD

Help protect your vehicle's side panels



### BIMINI TOP

**PART #:** 2877852-067  
**FITMENT:** eM1400, M1400

Provides shade and protection from the weather  
Easy to attach and remove  
Stores compactly  
Required, sold separately: Cab Frame Kit (PN 2880203) for use with GEM® eM™1400



### LOCK & RIDE® POLY ROOF

**PART #:** 2879109  
**FITMENT:** eM1400, eM1400 LSV, M1400

Installs quickly and easily, without tools, using Lock & Ride® technology and provides a sealed fit  
Provides outstanding overhead protection and shade to keep riders protected and comfortable  
Lightweight, strong and durable polyethylene construction  
Textured finish on polyethylene matches vehicle finish  
Required, sold separately: Cab Frame Kit (PN 2880203) for use with GEM® eM™1400



### LOCK & RIDE® POLY DOORS

**PART #:** 2879111  
**FITMENT:** eM1400, eM1400 LSV, M1400

Provides protection and comfort  
Windows can be opened, and pivoted as desired for airflow and exterior access  
Strong, durable structural web injection-molded shell  
Profile tubing and plastic design create sealed perimeter  
Lightweight, strong and durable polyethylene construction  
Textured finish on polyethylene matches vehicle finish  
Door is backed with sound-absorbing insulation material  
Required, sold separately: Cab Frame Kit (PN 2880203) for use on GEM® eM™1400



### CANVAS DOORS

**PART #:** 2879351  
**FITMENT:** eM1400, M1400

Installs easily and provides protection and comfort  
Features reliable latches and ventilation through the PVC windows with a magnetic closure  
Durable, heavy-duty 23-oz. canvas material  
Mold-resistant and UV-stable  
Heavy-duty powder-coated steel rod door frames  
Premium-quality paddle latches  
Required, sold separately: Cab Frame Kit (PN 2880203) for use on GEM® eM™1400





### FRONT FULL HARD DOOR

FITMENT: e2, e4, e6, eL XD	
COLOR	PART #
LH Black	2635825-666
LH Red	2635825-520
LH White	2635825-599
LH Blue	2635825-598
RH Black	2635826-666
RH Red	2635826-520
RH White	2635826-599
RH Blue	2635826-598



### MIDDLE/REAR FULL HARD DOOR

FITMENT: e4, e6	
COLOR	PART #
LH Black	2635827-666
LH Red	2635827-520
LH White	2635827-599
LH Blue	2635827-598
RH Black	2635828-666
RH Red	2635828-520
RH White	2635828-599
RH Blue	2635828-598



### HALF HARD DOOR

FITMENT: e2, e4, e6, eL XD	
COLOR	PART #
LH Black	2635867-666
LH Red	2635867-520
LH White	2635867-599
LH Blue	2635867-598
RH Black	2635868-666
RH Red	2635868-520
RH White	2635868-599
RH Blue	2635868-598

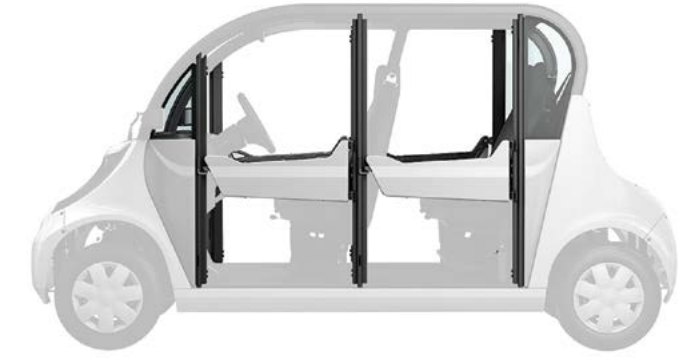

### QUARTER HARD DOOR

FITMENT: e2, e4, e6, eL XD	
COLOR	PART #
LH Black	2635863-666
LH Red	2635863-520
LH White	2635863-599
LH Blue	2635863-598
RH Black	2635864-666
RH Red	2635864-520
RH White	2635864-599
RH Blue	2635864-598



### SOFT CANVAS DOORS

<b>PART #:</b> 2881854 <b>FITMENT:</b> e2, eL XD
<b>PART #:</b> 2881855 <b>FITMENT:</b> e4
<b>PART #:</b> 2881856 <b>FITMENT:</b> e6

Features zip open and roll back for easy conversion from an enclosed cab to an open cab  
Can be easily removed and re-assembled



### REAR WINDOW

<b>PART #:</b> 5452161 <b>FITMENT:</b> e2, e4, e6, eL XD
---

Protect the interior from sun, wind and rain

*Door Mounting Kits and Filler Kits required for all doors when ordered separately from vehicles. See local dealer for more information regarding these parts.*







## CANVAS CAB POLY WINDSHIELD

**PART #:** 2879490  
**FITMENT:** eM1400, M1400

Installs quickly and easily, without tools, using Lock & Ride® technology  
Strong, durable polycarbonate construction  
Provides the best impact, scratch and chip resistance  
Full exterior gasket for sealed installation  
Radiused design for automotive fit, improved acoustics  
Required, sold separately: Cab Frame Kit (PN 2880203)



## GLASS WINDSHIELD

**PART #:** 2880885  
**FITMENT:** eM1400

Shatterproof, scratch-resistant, optical-grade laminate safety glass offers the best rider protection and visibility  
Protects riders from wind, rain, vehicle spray and more  
Required, sold separately: Cab Frame Kit (PN 2880203)



## LOCK & RIDE® HARD COAT POLY WINDSHIELD

**PART #:** 2879108  
**FITMENT:** eM1400, M1400

Installs quickly and easily, without tools, using Lock & Ride® technology  
Strong, durable polycarbonate construction  
Provides the best impact, scratch and chip resistance  
Full exterior gasket for sealed installation  
Radiused design for automotive fit, improved acoustics  
Required, sold separately: Cab Frame Kit (PN 2880203)



## POLY REAR PANEL

**PART #:** 2879950  
**FITMENT:** eM1400, eM1400 LSV, M1400

Installs quickly and easily, without tools, using Lock & Ride® technology  
Required, sold separately: Cab Frame Kit (PN 2880203) for use with GEM® eM™1400



## GLASS LOCK & RIDE® WINDSHIELD

**PART #:** 2879741  
**FITMENT:** M1400

Installs quickly and easily, without tools, using Lock & Ride® technology  
Features minimal perimeter framework for low-profile and full visibility  
Material: Laminate 6 mm automotive safety glass that is impact, shatter and scratch-resistant



## LOCK & RIDE® HALF WINDSHIELD

**PART #:** 2878757  
**FITMENT:** M1400

Durable, polycarbonate half windshield installs quickly and easily without tools  
Lock & Ride® clamps lock onto the vehicle frame to hold the windshield securely in place  
Provides a combination of protection and ventilation options  
Open space above windshield promotes airflow into seating area



## CANVAS ROOF & REAR PANEL

**PART #:** 2879350  
**FITMENT:** eM1400, M1400

Easy to install or remove for lightweight overhead and rear protection as needed  
PVC rear window provides reliable protection and visibility  
Rear panel provides protection, prevents dust swirl  
Required, sold separately: Cab Frame Kit (PN 2880203) for use with GEM® eM™1400







# BUMPERS & WINCHES

Visit [GEMCAR.COM](http://GEMCAR.COM)  
or contact your local dealer for pricing.



## FRONT RUGGED BUMPER

**PART #:** 2881627  
**FITMENT:** e2, e4, e6, eL XD

The rugged bumper adds extra front protection for heavy-duty work applications  
Powder-coated steel  
Does not work with: Front Chrome Bumper



## FRONT CHROME BUMPER

**PART #:** 2881629  
**FITMENT:** e2, e4, e6, eL XD

Chrome finish  
Protect your vehicle from scratches and dings  
Does not work with: Front Rugged Bumper



## REAR BUMPER

**PART #:** 2880879  
**FITMENT:** eM1400, eM1400 LSV

Heavy steel construction provides protection for rear of vehicle



## STEP NERF BARS

**PART #:** 2877703-458  
**FITMENT:** eM1400, eM1400 LSV, M1400

Protect the vehicle from impacts with rocks, stumps and debris  
Provide a step when a rider is climbing into or out of the vehicle  
Rugged tubular construction ensures long-term durability and reliability



## REAR RUGGED BUMPER

**PART #:** 2881628  
**FITMENT:** e2, e4, e6

Powder coated steel  
Protect your vehicle from scratches and dings  
Integrate 1 1/4 inch hitch  
Does not work with: Rear Chrome Bumper



## REAR CHROME BUMPER

**PART #:** 2881630  
**FITMENT:** e2, e4, e6

Chrome finish  
Protect your vehicle from scratches and dings  
Does not work with: Rear Rugged Bumper



## POLARIS® PRO HD 4500 LB. WINCH

**PART #:** 2879280  
**FITMENT:** M1400

4,500 lbs. (2041 kg) rated pull  
1.5-hp permanent magnet motor  
Auto-Stop Technology stops winch at end of pull/lift to prevent stress on driveline components, and prevents over lifting of plows and over-retrieving of rope on pulls  
Near-silent free spool operation - 40% quieter  
Polished, corrosion-resistant aluminum hawse fairlead  
Corded remote control  
50 feet of 6 mm premium, high-strength synthetic rope



## POLARIS® 3500 LB. INTEGRATED WINCH

**PART #:** 2878784  
**FITMENT:** eM1400, eM1400 LSV

3,500 lbs. rated pull  
50 feet of 7/32 inch high-strength steel cable  
Sealed motor and gear train to ensure reliable operation in extreme conditions  
Includes: mini-rocker corded switch, roller fairlead, hook and strap and all mounting hardware and installation wiring



## REAR RUGGED BUMPER

**PART #:** 2881683  
**FITMENT:** eL XD

Powder coated steel  
Protect your vehicle from scratches and dings







LIGHTS	PART #	FITMENT	DESCRIPTION
Amber Security Light Bar	2412057	eM1400 eM1400 LSV M1400	Easy to install light design by Code 3 Rotating light



Blue Security Light Bar	2412058	eM1400 eM1400 LSV M1401	Easy to install light design by Code 3 Rotating light
-------------------------	---------	-------------------------------	--



Red Security Light Bar	2412059	eM1400 eM1400 LSV M1402	Easy to install light design by Code 3 Rotating light
------------------------	---------	-------------------------------	--



Amber LED Light Bar	2412060	eM1400 eM1400 LSV M1405	Clear lens with amber colored LEDs Low profile for a stealth look Draws 50-75% less amps than a standard mechanical security light bar
---------------------	---------	-------------------------------	--



Blue LED Light Bar	2412061	eM1400 eM1400 LSV M1403	Clear lens with blue LEDs Low profile for a stealth look Draws 50-75% less amps than a standard mechanical security light bar
--------------------	---------	-------------------------------	---



Red LED Light Bar	2412062	eM1400 eM1400 LSV M1400	Clear lens with red LEDs Low profile for a stealth look Draws 50-75% less amps than a standard mechanical security light bar
-------------------	---------	-------------------------------	--



Blue/Red LED Light Bar	2412063	eM1400 eM1400 LSV M1406	Clear lens with blue/red LEDs Low profile for a stealth look Draws 50-75% less amps than a standard mechanical security light bar
------------------------	---------	-------------------------------	---

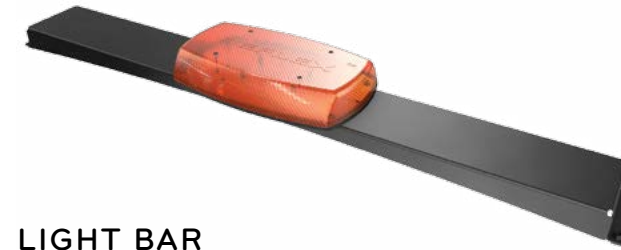

## LIGHT BAR

**PART #:** 2881803  
**FITMENT:** e2, e4, e6, eL XD

Great for industrial applications  
Amber colored roof mounted bar light adds visibility for safer operation  
Does not work with: Beacon Light



## BEACON LIGHT

**PART #:** 2880912  
**FITMENT:** eM1400, eM1400 LSV, M1400

Great for industrial applications  
Amber colored roof mounted beacon light adds visibility to the vehicle for safer operation  
All wiring and hardware is included  
Required, sold separately: Poly Roof Kit (PN 2879109)



## 27" DUAL ROW LIGHT BAR

**PART #:** 2879858  
**FITMENT:** eM1400, eM1400 LSV, M1400

Lights produce a total of 21,260 lumens of illumination  
Side flood lenses provide a wide lighting periphery for optimized visibility  
Required, sold separately: Wire Harness (PN 2879863), Cab Frame (PN 2880203) and Poly Roof Kit (PN 2879109)



## LED HEADLIGHTS

**PART #:** 2413083  
**FITMENT:** e2, e4, e6, eL XD

Provides brighter light for added safety



## BEACON LIGHT

**PART #:** 2881802  
**FITMENT:** e2, e4, e6, eL XD

Great for industrial applications  
Amber colored roof mounted beacon light adds visibility for safer operation  
Does not work with: Light Bar



## 12" LIGHT BAR

**PART #:** 2879500  
**FITMENT:** eM1400, eM1400 LSV, M1400

9.5-watt LEDs produce 2,100 lumens of illumination with a low electrical draw  
Required, sold separately: Wire Harness (PN 2879863)





# PASSENGER CARRIERS

Visit [GEMCAR.COM](http://GEMCAR.COM)  
or contact your local dealer for pricing.



## S-BED

**PART #:** 2881502  
**FITMENT:** e2, e4, e6

Easily convert the back of your GEM® to carry more cargo  
Payload capacity of 330 lbs. when installed  
Measures 30.7" x 40"  
Does not work with: Trunk Back and Linkback



## S-BED STAKE SIDES

**PART #:** 2881503  
**FITMENT:** e2, e4, e6

Durable support for hauling and transporting larger, bulky loads  
Easy to remove sides for oversized loads  
Required, sold separately: S-Bed (PN 2881502)  
Does not work with: Trunk Back and Linkback



## LINKSBACK

**PART #:** 2881634  
**FITMENT:** e2, e4, e6

Carries two golf bags  
Does not work with: S-Bed, S-Bed Stake Sides,  
S-Bed Solid Sides, Trunkback, Rear Rugged Bumper  
and Rear Chrome Bumper



## TRUNK BACK

**PART #:** 2881504  
**FITMENT:** e2, e4, e6

Lockable and removable design that is easy to install and remove  
Perfect for groceries or other small cargo  
Measures 33" x 16" x 15"  
100 lb. carrying capacity  
Does not work with: S-Bed, Stake Sides, Solid Sides  
and Linkback



## S-BOX

**PART #:** 2881626  
**FITMENT:** e2, e4, e6

Lockable, weather-tight, enclosed cargo carrier is perfect for transporting food and cargo, supplies or tools  
Features hinged supported door and high-quality lockable door latch  
Large, 25 cu ft storage capacity  
Dimensions 18" x 18" x 48"  
Required, sold separately: S-Bed (PN 2881502)  
Does not work with: Trunk Back, S-Bed Stake Sides, S-Bed Solid Sides and Linkback



## S-BED SOLID SIDES

**PART #:** 2881505  
**FITMENT:** e2, e4, e6

Durable support for hauling and transporting larger, bulky loads  
Easy to remove sides for oversized loads  
Solid sides help eliminate cargo from falling out  
Required, sold separately: S-Bed (PN 2881502) and S-Bed Stake Sides (PN 2881503)  
Does not work with: Trunk Back and Linkback

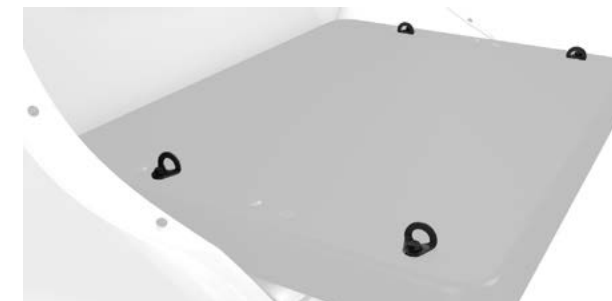

## S-BED TIE DOWNS

**PART #:** 2881781  
**FITMENT:** e2, e4, e6

Help secure your cargo with these easy to install tie downs  
Required, sold separately: S-Bed (PN 2881502)  
Does not work with: Trunk Back and Linkback



PASSENGER CARRIERS





## FRONT TOOL CHEST

**PART #:** 2881632  
**FITMENT:** eL XD

Keep tools and equipment in a convenient location  
Lockable for added security  
Measures 47.25" x 20" x 19.5" and has a 200 lb. carrying capacity  
Does not work with: Front Panel



## SIDE TOOL CHEST

**PART #:** 2881633  
**FITMENT:** eL XD

Fits the length of the flat bed and allows an open space in between for items that won't fit inside the boxes  
Lockable for added security  
Does not work with: Boxside and L-Box



## FRONT PANEL

**PART #:** 2881778  
**FITMENT:** eL XD

Used with solid sides without Front Tool Chest  
Durable support for hauling and transporting larger, bulky loads  
Protects cabin from loads in box  
Required, sold separately: Boxsides (PN 2881777)  
Does not work with: L-Box and Side Tool Chest



## STAKEBACK

**PART #:** 2881682  
**FITMENT:** eL XD

Durable support for hauling and transporting larger, bulky loads  
Easy to remove sides for oversized loads



## BOXSIDE

**PART #:** 2881777  
**FITMENT:** eL XD

Durable support for hauling and transporting larger, bulky loads  
Easy to remove sides for oversized loads  
Solid sides help eliminate cargo from falling out  
Hinged for easy access  
Required, sold separately: Front Panel (PN 2881778), or Front Toolbox (PN 2881632) with Boxside Toolbox Adapter (PN 2881780) for mounting  
Does not work with: L-Box



## LADDER RACK

**PART #:** 2881663  
**FITMENT:** eL XD

Ideal for transporting long items such as ladders, pipe, lumber or other building and maintenance supplies  
Rated for up to 75 lbs. of cargo  
Can be installed with Bed Sides or Toolboxes  
Does not work with: L-Box

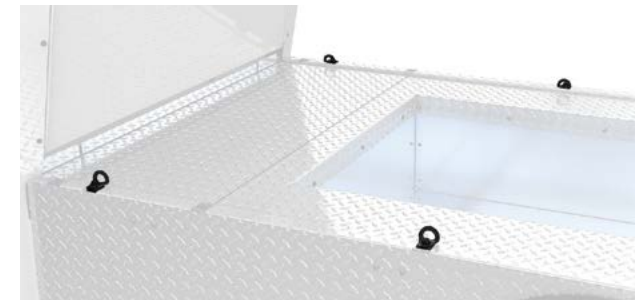

## eL XD BED TIE DOWNS

**PART #:** 2881722  
**FITMENT:** eL XD

Help secure your cargo with these easy to install stainless tie down brackets



## L-BOX

**PART #:** 2881631  
**FITMENT:** eL XD

Features a 44 inch cab high canopy box, lined rear door and a full length side door for easy access to cargo  
Only works with a recessed bed  
Does not work with: Boxside, Ladder Rack, Front Tool Chest, Side Tool Chest and Front Panel

## BOXSIDE TOOLBOX ADAPTER

**PART #:** 2881780  
**FITMENT:** eL XD

Used to adapt the front toolbox to mount solid sides



## RECESSED BED COVER

**PART #:** 2881681  
**FITMENT:** eL XD

These panels create a flat bed on the eL XD for hauling





## HINGED TAILGATE

**PART #:** 2881869  
**FITMENT:** eL XD

Hinged tailgate drops down for easy loading/unloading of cargo



## RAMPED TAILGATE

**PART #:** 2881870  
**FITMENT:** eL XD

Roll heavy cargo on and off your GEM®



## LOCK & RIDE® CHAINSAW MOUNT

**PART #:** 2879354  
**FITMENT:** eM1400, eM1400 LSV, M1400

Installs quickly and easily, without tools, using Lock & Ride® technology

Can be secured to the outside of the bed wall, so your chainsaw is within reach at all times allowing you to maximize the bed space for other cargo

Required, sold separately: Bed Sides (PN 2880070)



## MANUAL BOX LIFT

**PART #:** 2880418  
**FITMENT:** eM1400, eM1400 LSV

**PART #:** 2880999  
**FITMENT:** M1400

Manual latch to release bed tilt and hydraulic shock to hold bed in dump position

All mounts are integrated into the chassis for easy installation  
Includes all hardware



## ELECTRIC BOX LIFT

**PART #:** 2880145  
**FITMENT:** eM1400, eM1400 LSV

**PART #:** 2880948  
**FITMENT:** M1400

Heavy-duty actuator raises/lowers cargo box

All mounts are integrated into the chassis for easy installation

Dump dirt, sand or mulch with the flip of a switch

Includes all hardware and a dash-mounted switch



## REMOVABLE LOCK & WORK™ BED SIDES

**PART #:** 2880070  
**FITMENT:** eM1400, eM1400 LSV, M1400

Contain your cargo with solid 12 inch tall sides and a removable rear panel.

Easily removed and installed using Lock & Work™ Technology



## LOCK & WORK™ MAX BOX STANDARD DOOR

**PART #:** 2880144  
**FITMENT:** eM1400, eM1400 LSV, M1400

Easily removed and installed using Lock & Work™ Technology

Fully enclosed storage box keeps cargo and gear secure and dry

Dimensions 54" x 42" x 42"

Cannot be used with: Poly Roof (PN 2579950)



## LOCK & RIDE® CARGO BOX

**PART #:** 2879230  
**FITMENT:** eM1400, eM1400 LSV, M1400

Keeps your tools safe and secure

Installs quickly and easily, without tools, using Lock & Ride® technology

Oversized hinged lid provides full, easy access to cargo

Durable Polyethylene Construction

Required, sold separately: Bed Sides (PN 2880070) or Box Sides (PN 2634373)



## 60 GALLON BOOMLESS UTILITY SPRAYER

**PART #:** 2879799  
**FITMENT:** eM1400, eM1400 LSV, M1400

Features a 60-gallon corrosion-resistant polyethylene tank, 12-volt diaphragm pump, and a pressure gauge with adjustable spray pressure

Delivers fluids at a rate of up to 3.8 gpm with a 45 psi maximum  
Deluxe pistol grip handgun with an adjustable nozzle and 25 foot hose

Spray gun horizontal throw is 35 feet, with a maximum vertical throw of 26 feet

Boomless nozzles can deliver across a full 30 foot spray coverage area

Material: Polyethylene tank

Required, sold separately: Bed Sides (PN 2880070)





Polaris® LSVs comply with the NHTSA Low Speed Vehicles rules and regulations and can be operated on many streets with posted speed limits of 35 mph or less. Check local laws regarding street use and vehicle equipment requirements. Drivers must be at least 16 years old with a valid driver's license. Driver and passengers should always wear seat belts. Where appropriate for work and riding conditions, helmets and eye protection should also be worn. Never engage in stunt driving, and avoid excessive speeds and sharp turns. Range on all Polaris® electric vehicles will vary depending on temperature, grade, payload, and driving style. All pricing, specifications, claims, and information contained in this brochure are based on information available at the time of publication. Polaris® assumes no responsibility for any inaccuracies, opinions, or omissions in those publications. All pricing, specifications, and descriptions are subject to change without notice, and Polaris® assumes no responsibility for changes in pricing or specifications. Unless otherwise noted, all trademarks are the property of Polaris Industries Inc.

©2016 Polaris Industries Inc.  
Part No. 9930198

[GEMcar.com](http://GEMcar.com) | 1-855-RIDE-GEM

